

Drainage Castings

Click on a category below for detailed technical specifications

- 2** Manhole Covers & Frames
- 3** Gully Grates & Frames
- 6** Traditional Manhole Covers
- 7** Arterial Covers & Frames
- 9** Kerb Units
- 10** Gullies
- 13** Surface Boxes
- 14** Buchan Gratings & Frames
- 16** Straight Bar Gratings
- 17** Hart Trap Gratings
- 18** Interceptor Traps

For further information about our products and services contact us:

Ballantine Castings Ltd.
Links Road, Bo'ness EH51 9PW

T: 01506 822 721

F: 01506 827 326

E: sales@ballantineboness.co.uk

www.ballantinecastings.co.uk

2

Manhole Covers & Frames

D400 Ductile Iron. MI50

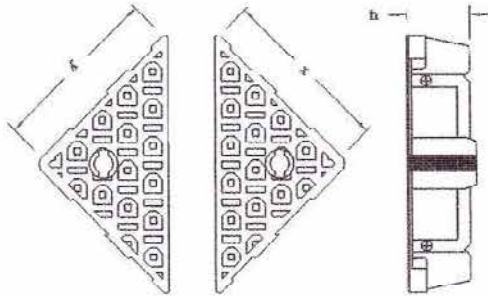

Clear Openings		Cover Dimensions		
x	y	x	y	H
225	225	216	216	85
300	300	291	291	85
380	230	387	232	72
600	450	609	455	89
600	600	605	605	86
675	675	668	668	85
750	600	755	605	85
905	605	905	605	85

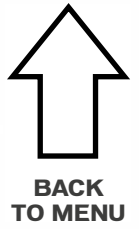

Clear Openings		Cover Dimensions		
x	y	x	y	H
225	225	335	335	100
300	300	410	410	100
380	230	490	340	100
600	450	763	613	100
600	600	763	763	100
600	600	760	760	150
675	675	825	825	100
750	600	913	763	100
750	600	913	763	150
900	600	1093	763	100

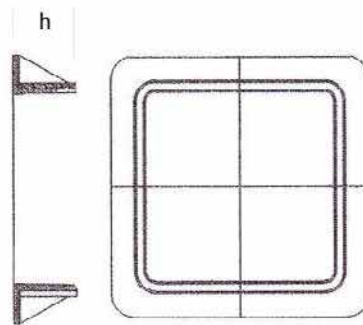

Multiples 900 x 900 C/O
 1200 x 875 C/O
 1200 x 675 C/O

D400 Ductile Iron. MI51

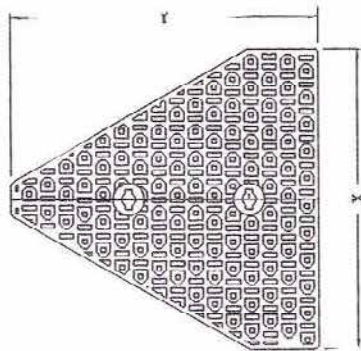

Clear Openings		Cover Dimensions		
x	y	x	y	H
600	600	649	664	100



Clear Openings		Cover Dimensions		
x	y	x	y	H
600	600	800	800	100

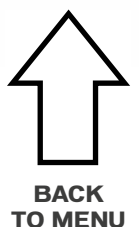
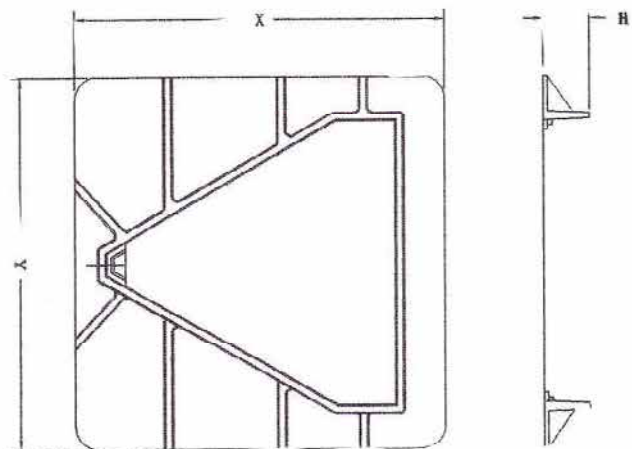

3

Gully Grates & Frames

C250 Ductile Iron. M161

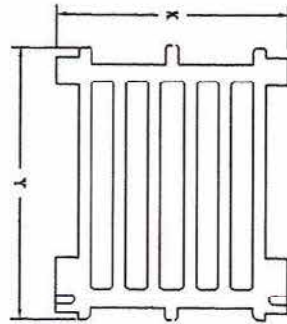

Frame Dimentions

X	Y	H
972	718	90
822	868	90
822	716	90
672	718	70
672	588	70
522	588	75
572	468	75
507	553	75
502	488	75
502	488	75
452	422	75
397	412	75

Cover Dimentions

X	Y	H
900	600	90
750	750	90
750	600	90
600	600	70
600	450	70
450	450	75
500	350	75
435	435	75
430	370	75
430	370	75
430	295	75
300	300	75

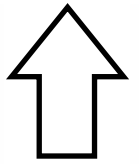
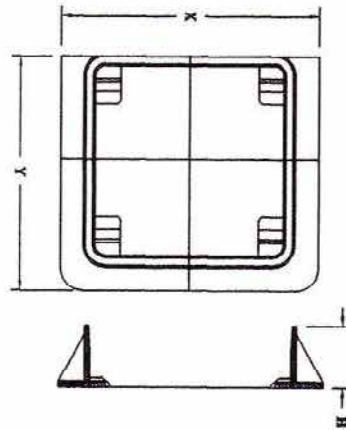

BACK TO MENU

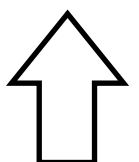

BACK TO MENU

4

Gully Grates & Frames

Gully Gratings and Frames,
Flat Top, Hinged and
Lockable in Grey Iron
M 045

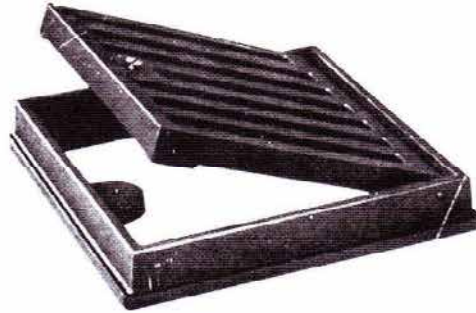

Old B.I. Cat. No.	New Ball Cat. No.	Clear Opening (mm)	Overall Size (mm)	Depth (mm)	Weight (kgs)	EN124 Loading
4001	M 045	130 x 130	150 x 150	25	2.3	A15
4028	M 045	205 x 205	280 x 280	38	14	A15
4074	M045	255 x 255	330 x 330	38	15	A15
4130	M 045	305 x 305	395 x 395	38	12	A15
4002	M 045	150 x 150	240 x 240	50	11	B125

Gully Gratings and Frames,
Flat Top, Hinged in Grey Iron
M 046

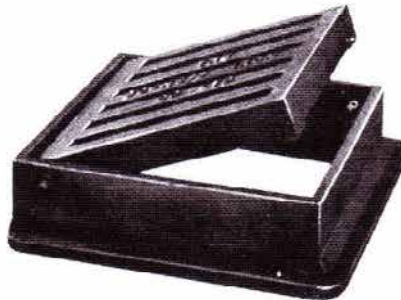

Old B.I. Cat. No.	New Ball Cat. No.	Clear Opening (mm)	Overall Size (mm)	Depth (mm)	Weight (kgs)	EN124 Loading
4148	M 046	305 x 305	430 x 405	100	44	B125
4230	M 046	380 x 380	535 x 535	100	73	B125
4306	M 046	460 x 330	610 x 430	100	98	B125
4048	M 046	230 x 230	395 x 355	75	29	D400

Gully Gratings and Frames,
Drop in, Channelled in
Grey Iron
M 047

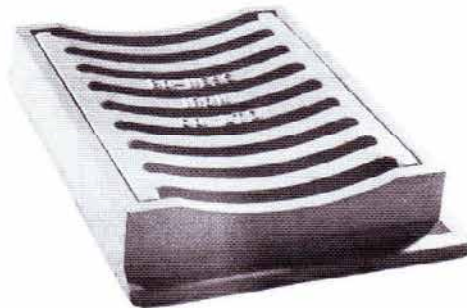

Old B.I. Cat. No.	New Ball Cat. No.	Clear Opening (mm)	Overall Size (mm)	Depth (mm)	Weight (kgs)	EN124 Loading
4181	M 047	345 x 320	445 x 420	90	47	B125
4077	M 047	265 x 265	395 x 370	90	51	D400

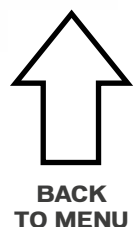

5

Gully Grates & Frames

Gully Gratings and Frames,
Flat Top, Hinged and
Channelled in Grey Iron
M 049

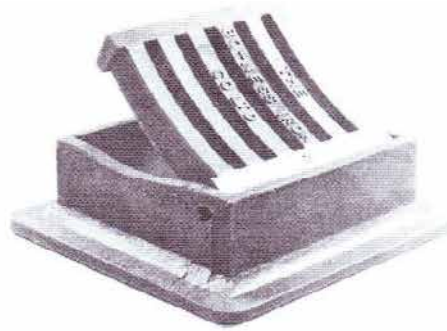

Old B.I. Cat. No.	New Ball Cat. No.	Clear Opening (mm)	Overall Size (mm)	Depth (mm)	Weight (kgs)	EN124 Loading
4116	M 049	305 x 255	425 x 345	75	31	B125
4144	M 049	305 x 305	445 x 445	89	41	B125
4228	M 049	380 x 380	510 x 460	100	69	B125
4304	M049	460 x 330	610 x 470	100	70	B125
4120	M 049	305 x 280	460 x 425	125	56	D400
4156	M 049	325 x 325	610 x 510	150	101	D400

Gully Gratings and Frames,
Flat Top, Drop In, in Grey Iron
M 050

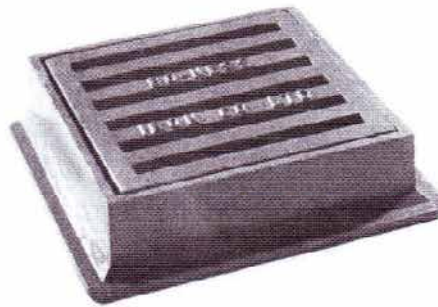

Old B.I. Cat. No.	New Ball Cat. No.	Clear Opening (mm)	Overall Size (mm)	Depth (mm)	Weight (kgs)	EN124 Loading
4133	M 050	305 x 305	395 x 395	75	27	A15
4145	M050	305 x 305	460 x 460	100	44	C250
4229	M 050	380 x 380	535 x 485	100	69	C250
4305	M 050	460 x 330	610 x 460	100	98	C250
4329	M 050	460 x 460	610 x 610	100	110	C250

Gully Gratings and Frames,
Flat Top, Hinged Steel Gratings
in Grey Iron Frame
M 056



Old B.I.	New Ball	Clear Opening	Overall Size	Depth	Weight	EN
----------	----------	---------------	--------------	-------	--------	----

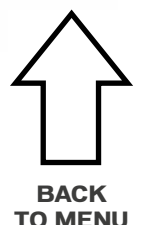

6

Traditional Manhole Covers

Flat Top, Single Seal,
Drop in Manhole Covers
and Frames in Grey Iron
M 010

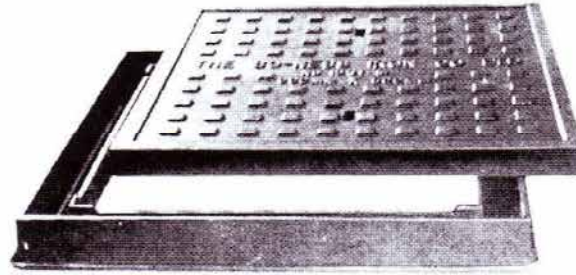

Old Ball. Cat No.	Old B.I. Cat. No.	New Ball Cat. No.	Clear Opening (mm)	Overall Size (mm)	Depth (mm)	Weight (kgs)	EN124 Loading
	1001	M 010	150 x 150	240 x 240	25	5.5	A15
1		M 010	230 x 230	310 x 310	38	13.5	A15
1		M 010	305 x 305	420 x 420	38	19	A15
1		M 010	380 x 380	510 x 510	38	22.5	A15
1		M 010	460 x 305	590 x 450	38	22.5	A15
1		M 010	460 x 460	570 x 570	38	30	A15
	1175	M 010	610 x 460	760 x 610	50	42	A15
	1215	M 010	610 x 610	760 x 760	44	74	A15
2		M 010	760 x 610	925 x 760	50	83	A15
2		M 010	760 x 760	925 x 925	50	106	A15
	1351	M 010	915 x 610	1040 x 760	44	97	A15
2		M 010	915 x 760	1070 x 920	50	121	A15
2		M 010	915 x 915	1050 x 1050	50	132	A15
2		M 010	1070 x 760	1230 x 925	50	147	A15
2		M 010	1070 x 915	1220 x 1060	50	178	A15
2		M 010	1220 x 915	1395 x 1080	50	196	A15
	1027	M 010	305 x 305	460 x 460	50	32	C230
	1089	M 010	460 x 460	675 x 675	75	90	C250
	1129	M 010	535 x 535	750 x 750	75	112	C250
	1230	M 010	610 x 610	775 x 775	50	113	B125
	1239	M 010	610 x 610	825 x 825	125	224	C250
	1255	M 010	685 x 685	940 x 940	75	137	B125
	1297	M 010	760 x 610	990 x 840	75	172	B125
	1321	M 010	760 x 760	965 x 965	90	199	B125
	1363	M 010	915 x 610	1090 x 790	75	165	B125
	1101	M 010	460 x 460	660 x 660	125	173	D400
	1199	M 010	610 x 460	815 x 660	125	192	D400
	1241	M 010	610 x 610	825 x 825	125	254	D400
	1309	M 010	760 x 610	990 x 840	125	289	D400
	1371	M 010	915 x 610	1120 x 815	125	321	D400

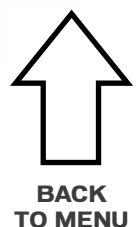

7

Arterial Covers & Frames

Arterial Side Entry Gully Covers and Frames in Grey Iron M 059



Old B.I. Cat. No.	New Ball Cat. No.	Clear Opening (mm)	Overall Size (mm)	Depth (mm)	Type	Weight (kgs)
5118	M 059	460 x 380	565 x 510	205	Square Front Hinged	95
5122	M 059	485 x 380	560 x 460	205	Square Front Hinged & Locking	118
5124	M 059	485 x 380	560 x 460	205	1/2 Batter Hinged & Locking	118
5126	M 059	485 x 380	560 x 460	205	45° Batter Hinged & Locking	118

Arterial Side Entry Gully Covers and Gratings in Grey Iron M 060

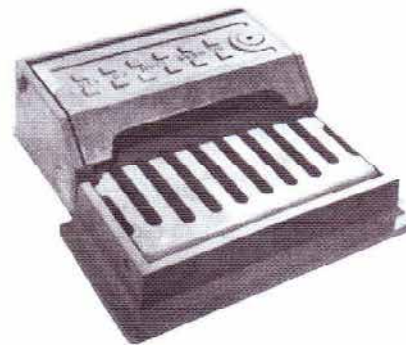

Old B.I. Cat. No.	New Ball Cat. No.	Clear Opening (mm)	Overall Size (mm)	Depth (mm)	Type	Weight (kgs)
5120	M 060	475 x 280	560 x 320	205	45° or Half Batter Hinged and Locking	70
5120	M 060	510 x 255	650 x 320	100	Front of Above Square Front Hinged Grating	56

Kerb Weirs in Grey Iron M 061

Old B.I. Cat. No.	New Ball Cat. No.	Length (mm)	Breath (mm)	Depth (mm)	Type	Nozzle (diam.mm)	Weight (kgs)
5201	M 061	305	125	255	Half Batter	100	30
5203	M 061	305	125	255	Half Batter	150	32

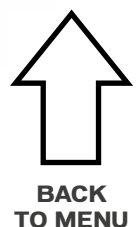

8

Arterial Covers & Frames

M 075

The “Interlockinglockable” Gully
Four Part Set in Ductile Iron
Side Entry Arterial Gully Grade A

Old Bo’ness Iron Cat. No. M-5120-D

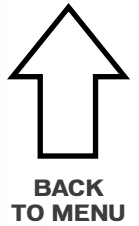
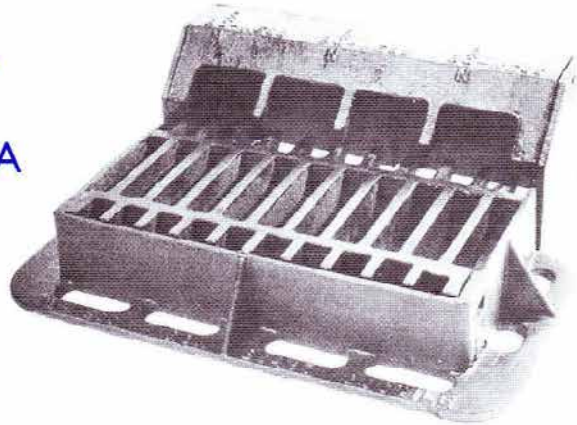

Cover and Frame, Hinged and Locking

Clear Opening (mm)	Depth (mm)	Batter	Area of Waterway (cm ²)
500 x 150	200	45° or half	350

Total area of waterway 1090 cm²

Grating and Frame, Hinged and Interlocked with the Above.

Clear Opening (mm)	Depth (mm)	Batter	Area of Waterway (cm ²)
500 x 250	100	Square Front	740

Total clear opening of set 500 x 400 mm

Total weight of set 58 kgs

M 076

The “Interlockinglockable” Gully
Four Part Set in Ductile Iron
Side Entry Arterial Gully Grade A

Old Bo’ness Iron Cat. No. M-5121-D

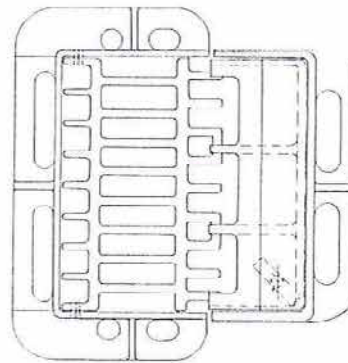
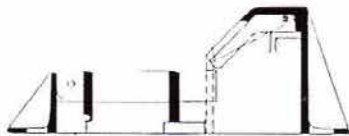

Cover and Frame, Hinged and Locking

Clear Opening (mm)	Depth (mm)	Batter	Area of Waterway (cm ²)
390 x 150	200	45° or half	250

Total area of waterway 890 cm²

Grating and Frame, Hinged and Interlocked with the Above.

Clear Opening (mm)	Depth (mm)	Batter	Area of Waterway (cm ²)
390 x 215	100	Square Front	640

Total clear opening of set 390 x 305 mm

Total weight of set 44 kgs

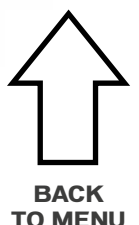

9 Kerb Units

M 078

45° Kerb Outlet in Ductile Iron with Grey Iron Retaining Bar

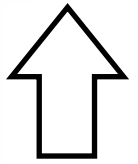

BACK TO MENU

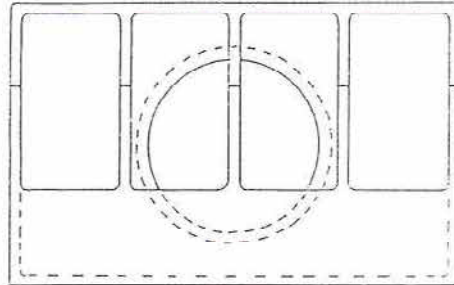
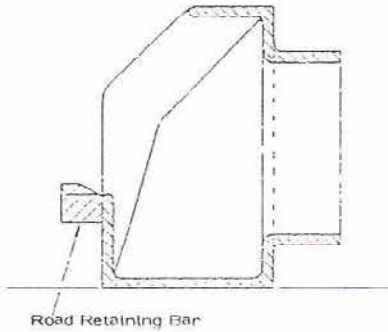

Old B.I. Cat. No.	New Ball Cat. No.	Size over Top (mm)	Breadth (mm)	Depth (mm)	Batter	Diam. of Outlet (mm)	Weight (kgs)
5204-D	M 078	400	150	250	45°	150 rear outlet	24
5205-D	M 078	400	150	250	45°	100 bottom outlet	24

M 078A

Tayside Clearways

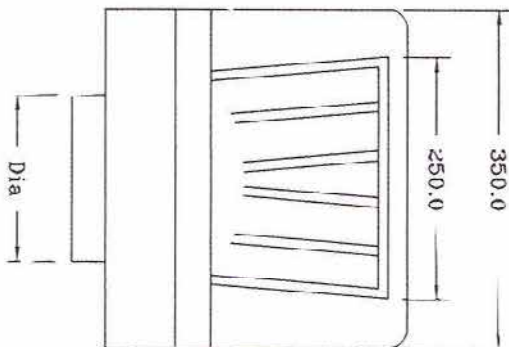
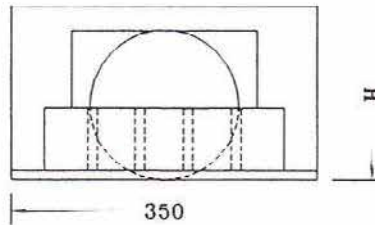
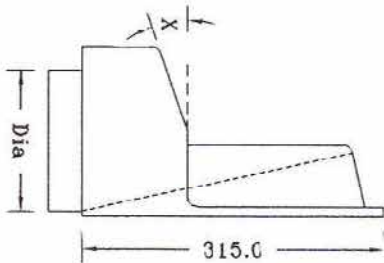

Diameter of Outlet	Overall Height	Batter Angle
100mm	175mm	15/45
100mm	200mm	15/45
150mm	175mm	15/45
150mm	200mm	15/45



Drainage Castings

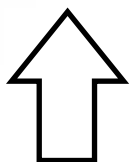

BACK TO MENU

M 081

Glenrothes Pattern Gully in Grey Iron with Internal Slide

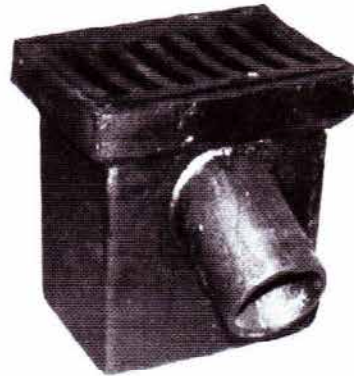

Old B.I. Cat. No.	New Ball Cat. No.	Length (mm)	Width (mm)	Depth (mm)	Outlet	Type	Weight (kgs)
4730	M 081	305	205	355	100	Hinged Channelled	49

M 086

Yard Gullies with Gratings in Grey Iron, complete with Galvanised Sediment Pan

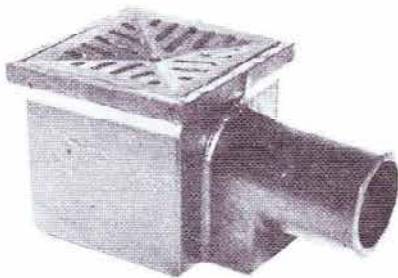

Fig. 37

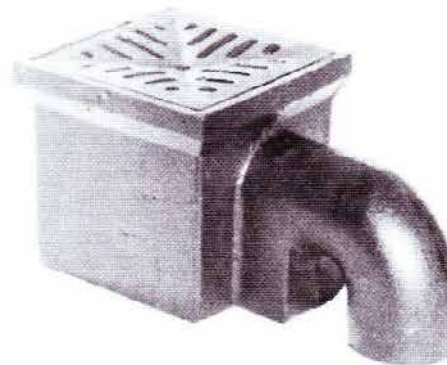
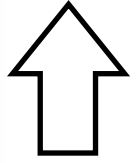

Fig 38

Old B.I. Cat. No.	New Ball Cat. No.	Fig. No.	Length (mm)	Width (mm)	Depth (mm)	Diameter of outlet (mm)	Type	Weight (kgs)
4506	M 086	37 or 38	230	230	230	100	Drop-in dished	29
4532	M 086	37 or 38	305	305	230	100	Drop-in dished	48
4556	M 086	37 or 38	305	305	305	100	Drop-in dished	45



BACK TO MENU

M 087

Yard Gullies with Gratings in Grey Iron, complete with Galvanised Sediment Pan and Channelled

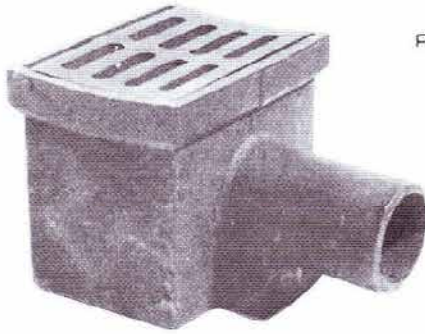

Fig. 39

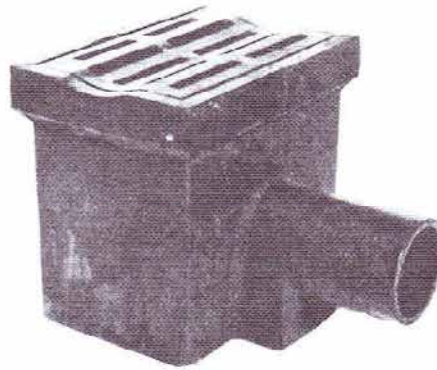

Fig. 40

Old B.I. Cat. No.	New Ball Cat. No.	Fig. No.	Length (mm)	Width (mm)	Depth (mm)	Diameter of outlet (mm)	Type	Weight (kgs)
4520	M 087	39	305	230	280	100	Hinged channelled	37
*4636	M 088	40	355	255	305	100	Drop-in channelled	51

*This item also available with a hinged, channelled grating.

M 097

Oil Industry BP Road Gully in Grey Iron

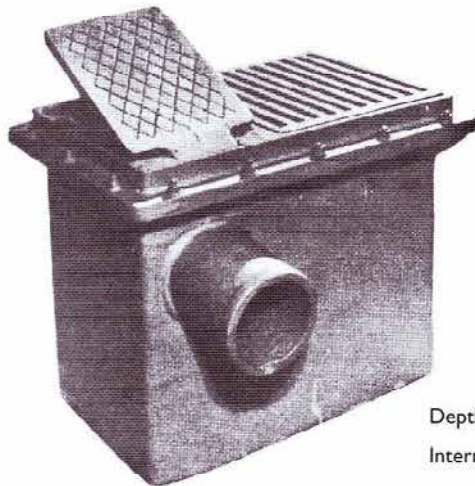

BP DRWG S 1241

Depth of Gully to Flange 545mm.

Internal Diam. of Outlet 100mm or 150mm.

Old Ball Cat. No.	Old B.I. Cat. No.	New Ball Cat. No.		Length (mm)	Width (mm)	Depth (mm)
BD173	4805	M 097	Overall top size of frame	700	450	
		M 097	Grating size	415	395	25
		M 097	Overall size	775	530	610
		M 097	Size of door on frame hinged	405	255	
		M 097	Gully body	685	380	535

Total weight per set 220 kgs.

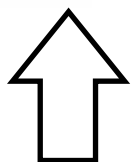

BACK TO MENU

M 090

Shelf Gullies complete with Gratings

with drop-in channelled grating

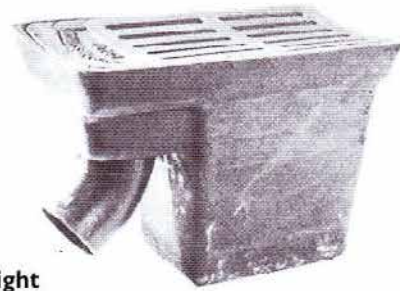

Old B.I. Cat. No.	New Ball Cat. No.	Length (mm)	Width (mm)	Depth (mm)	Outlet (mm)	Weight (kgs)
4753	M 090	660	335	445	125	100
4775	M 090	660	335	595	125	110

M 091

With Drop in Flat Top Grate

Old B.I. Cat. No.	New Ball Cat. No.	Length (mm)	Width (mm)	Depth (mm)	Outlet (mm)	Weight (kgs)
4755	M 091	660	335	445	125	106
4777	M 091	660	335	595	125	115

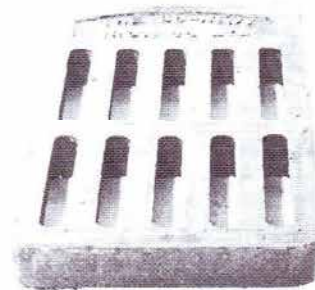

M 092

With Drop in Storm Bar Grating Channelled Only

Old B.I. Cat. No.	New Ball Cat. No.	Length (mm)	Width (mm)	Depth (mm)	Outlet (mm)	Weight (kgs)
4757	M 092	660	335	445	125	105
4779	M 092	660	335	595	125	115



Extension Piece for Shelf Gullies

M 093 as for Channelled Grating

Old B.I. Cat. No.	New Ball Cat. No.	Length (mm)	Width (mm)	Effective Depth (mm)	Weight (kgs)
4780	M 093	660	335	60	20

M 094 as for Flat Top Gratings

Old B.I. Cat. No.	New Ball Cat. No.	Length (mm)	Width (mm)	Effective Depth (mm)	Weight (kgs)
4781	M 094	660	335	60	18

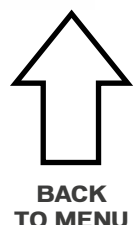

M 108

Circular Opening Hinged Covers and Frames in Grey Iron



Old B.I. Cat. No.	New Ball Cat. No.	Overall Size (diam. mm)	Depth (mm)	Weight (kgs)	EN124 Loading
6570	M 108	210	22	3.6	A15
6572	M 108	240	32	6.8	A15

M 109

Circular Opening Hinged Covers and Frames in Grey Iron

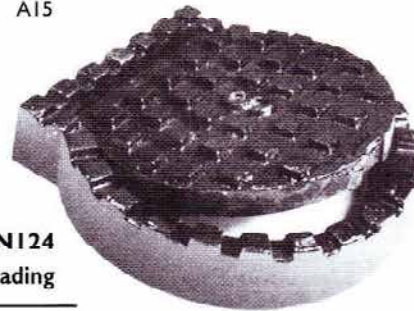

Old B.I. Cat. No.	New Ball Cat. No.	Overall Size (diam. mm)	Depth (mm)	Weight (kgs)	EN124 Loading
6570A	M 109	210	40	8.2	D400
6572A	M 109	260	48	12.7	D400
6573A	M 109	335	48	16.4	D400

M 111

Surface Boxes, Hinged Lid in Grey Iron

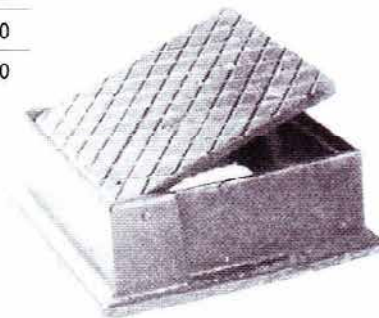

Old B.I. Cat. No.	New Ball Cat. No.	Top Opening (mm)	Bottom Opening (mm)	Overall Size (mm)	Depth (mm)	Weight (kgs)	EN124 Loading
5644	M 111	230 x 230	230 x 230	290 x 290	100	15	A15
5581	M 111	170 x 125	165 x 120	230 x 195	75	5	A15
5656	M 111	240 x 240	285 x 265	420 x 380	125	46.3	D400

M 112

Surface Boxes, Split Lid in Grey Iron

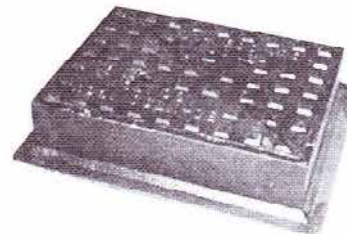

Old B.I. Cat. No.	New Ball Cat. No.	Top Opening (mm)	Bottom Opening (mm)	Overall Size (mm)	Depth (mm)	Weight (kgs)	EN124 Loading
5725	M 112	430 x 280	430 x 280	525 x 380	100	50	D400
5855	M 112	560 x 405	560 x 405	700 x 545	150	132	D400

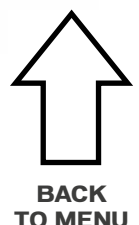

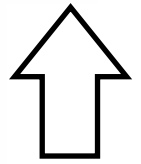

BACK
TO MENU

M 121

Buchan Gratings and Frames in Grey Iron

Can be supplied Drop-in or Locking

Old B.I. Cat. No.	New Ball Cat. No.	Size (mm)	Weight (kgs)	EN124 Loading
6003/6005	M 121	230 x 150 x 32	4.5	A15
6011/6013	M 121	305 x 150 x 32	6.4	A15
6019/6021	M 121	305 x 150 x 65	7.3	A15
6027/6029	M 121	305 x 150 x 90	13.0	A15
6035/6037	M 121	305 x 205 x 50	10.0	A15
6051/6053	M 121	355 x 180 x 32	6.8	A15
6067/6069	M 121	405 x 205 x 32	8.6	A15
6099/6101	M 121	460 x 305 x 100	27.0	A15

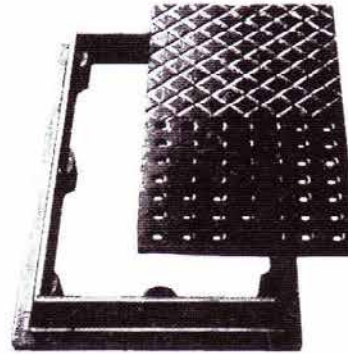

M 122

Buchan Gratings and Frames in Grey Iron

Can be supplied Drop-in or Locking

Old B.I. Cat. No.	New Ball Cat. No.	Size (mm)	Weight (kgs)	EN124 Loading
6043/6045	M 122	320 x 190 x 125	29	B125
6091/6093	M 122	405 x 255 x 125	71	B125

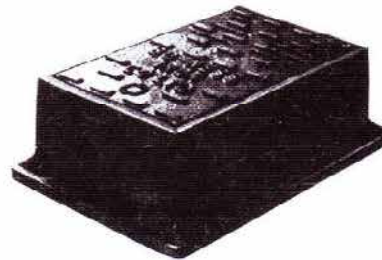

M 123

Square Buchan Gratings and Frames in Grey Iron

Also supplied with Solid Cover

Old B.I. Cat. No.	New Ball Cat. No.	Inside Size (mm)	Grating Size (mm)	Overall Size (mm)	Depth (mm)	Weight (kgs)	EN124 Loading
6209	M 123	140 x 140	150 x 150	215 x 215	38	5.4	A15
6223	M 123	180 x 180	180 x 180	240 x 240	38	5.4	A15
6237	M 123	195 x 195	205 x 205	255 x 255	38	6.4	A15
6245	M 123	220 x 220	230 x 230	290 x 290	38	8.2	A15
6253	M 123	290 x 290	305 x 305	370 x 370	38	12	A15

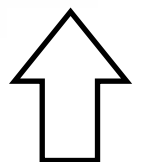
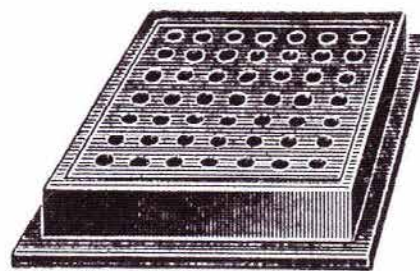

BACK
TO MENU

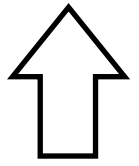

BACK TO MENU

M 125

Buchan Grates Circular in Grey Iron

8mm Thick

Diameter (mm)	Weight (kgs)
150	1
180	1
205	1.5
230	2

10mm Thick

Diameter (mm)	Weight (kgs)
125	0.8
140	0.8
150	1
180	1.7
205	2
230	2
255	2.5
305	3.5

13mm Thick

Diameter (mm)	Weight (kgs)
125	1



M 126

Buchan Grates Square in Grey Iron

Solid Covers available

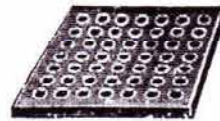

10mm Thick

Size (mm)	Weight (kgs)
100 x 100	0.5
125 x 125	0.5
150 x 150	1.5
190 x 190	2
205 x 205	2
230 x 230	2.5
240 x 240	4
255 x 255	4.5
280 x 280	5
305 x 305	5.5

13mm Thick

Size (mm)	Weight (kgs)
305 x 305	6.5
355 x 355	7.5
460 x 460	12.5

16mm Thick

Size (mm)	Weight (kgs)
205 x 205	4
230 x 230	5
240 x 240	5.5
255 x 255	6

19mm Thick

Size (mm)	Weight (kgs)
150 x 150	2.5
230 x 230	6
305 x 305	21.5

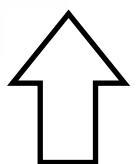

BACK TO MENU

M 127

Round Drain Grates in Grey Iron

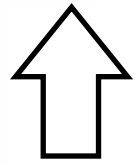
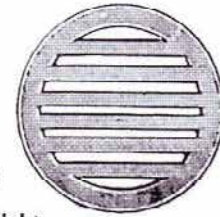

BACK TO MENU

10mm Thick

Diameter (mm)	Weight (kgs)
75	0.25
90	0.25
100	0.5
115	0.5
125	0.5
140	0.5
150	1
165	1
180	1
190	1.5

10mm Thick

Diameter (mm)	Weight (kgs)
205	1.5
215	1.5
230	2
240	2
255	2
265	2
280	2.5
290	2.5
305	2.5

13mm Thick

Diameter (mm)	Weight (kgs)
75	0.5
90	0.5
100	0.5
125	1
140	1
150	1
165	1.5
180	1.5
190	2
205	2

13mm Thick

Diameter (mm)	Weight (kgs)
230	2.5
255	3
265	3
280	3.5
290	4.5
305	5

19mm Thick

Diameter (mm)	Weight (kgs)
305	6
355	9
380	9.5

M 128

Square Drain Grates in Grey Iron

10mm Thick

Size (mm)	Weight (kgs)
100 x 100	0.5
115 x 115	1
125 x 125	1
140 x 140	1
150 x 150	1
165 x 165	1.5
180 x 180	1.5
205 x 205	1.5

10mm Thick

Size (mm)	Weight (kgs)
230 x 230	2
240 x 240	2
255 x 255	2
265 x 265	3
280 x 280	3
305 x 305	3

13mm Thick

Size (mm)	Weight (kgs)
100 x 100	1
150 x 150	1.5
180 x 180	2
205 x 205	2
230 x 230	2.5
255 x 255	3.5
305 x 305	6
355 x 355	7.5

25mm Thick

Size (mm)	Weight (kgs)
150 x 150	2.5

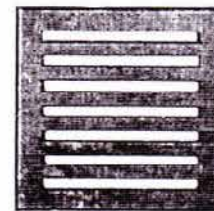

Coal Plates and Frames

M130 Solid

Diameter (mm)	Weight (kgs)
300	6



M131 Ventilated

Diameter (mm)	Weight (kgs)
300	7



M132 Self Locking Solid or Ventilated

Diameter (mm)	Weight (kgs)
300	10



BACK TO MENU

17

Hart Trap Gratings

M I33

Hart Trap Grating

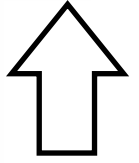

BACK TO MENU

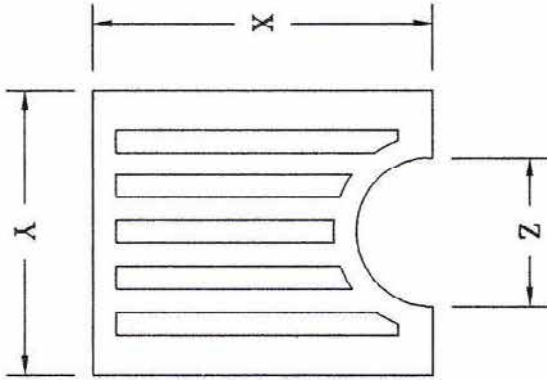

X	Y	Z
150	125	75
165	140	90
175	137	85
150	125	90
168	133	83
165	125	75
150	130	73
150	140	75
172	133	85
175	140	75
160	125	100
165	140	75

All 10mm Deep Thickness A15

M I44

Air Brick Grating

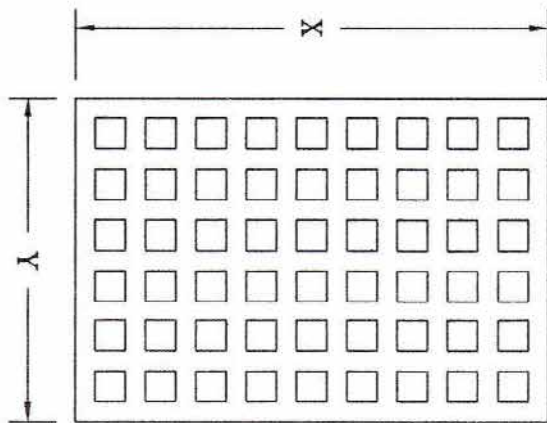

X	Y	Z
230	75	30
235	150	40
305	150	35
230	230	25
460	230	35
610	230	35
460	330	35
460	460	35

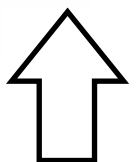
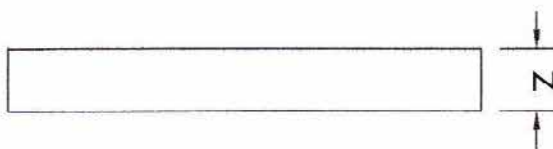

BACK TO MENU



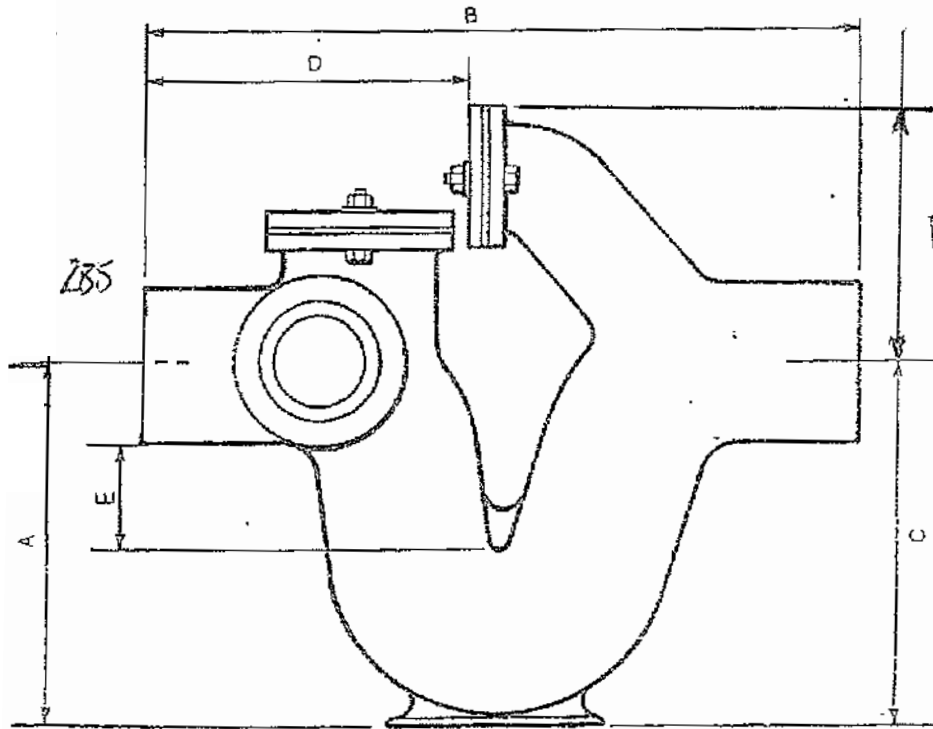

SD086B Disconnecting Trap

Nom. Int. Dia.	Mass kg	A	B	C	D	Seal E	F
100	38.0	240	575	205	235	55	210
150	60.0	310	695	280	280	55	290
225	152.0	465	935	405	455	65	298
300	259	572	1070	530	485		298
375	445	680	1320	665	565		

Handwritten '235' is next to the 'Seal E' column for the 225 DN row.

Traps are available with or without fresh air inlet. Fresh air inlet is 100 DN on 100 and 150 DN traps, and 150 DN on 225 DN traps.

Fresh air inlets are available either right or left hand. Left hand is shown.

OVERALL HEIGHT 225mm 750mm
300mm 870mm
100mm 460mm
150mm 600mm

